

SPECIFICATIONS

BOBCAT2.0 B1340



IMPERX: Technically superior products, full tech support, rapid-response customer care. “Bobcat 2.0” adds many new features, lens control, more memory and enhanced image quality. Each easy to use Bobcat is supported by IMPERX professionals.

INTERFACES AVAILABLE:

Resolution
Sensor
Sensor Format
Pixel Size
Frame Rate Standard Clock
Frame Rate Overclocked
Maximum Frame Rate
Minimum S/N Ratio
Output Format

Analog Gain Control
Black Level Control
Digital Gain and Offset
RGB Gain and Offset
White Balance
Shutter Speed
Exposure Control
Long Integration
Regions of Interest (ROI)
Binning H/V
Trigger Inputs

Trigger Options

Trigger Modes

Double Trigger (PIV) Interframe
External Inputs/Outputs
Strobe Output
RS232 Interface
Pulse Generator
Image Overlay
Image Enhancement

Internal DDR Memory
Gamma Correction
Data Corrections

Minimum Illumination
Lens Mount
Video Iris Control
Iris, Zoom Focus Control
Supply Input Range
Power Consumption

Size – Width/Height
Size – Length
Weight
Vibration, Shock
Environmental
Humidity
MTBF
Regulatory

Camera Link® Base or Medium, CoaXPress
1280 x 720 (std.), 1312 x 728 (max.)
KAI-01150, CCD
7.04mm (H) x 3.96mm (V) 8.08mm diagonal
1/2” optical format
5.50 µm
40 MHz / 135 fps
50 MHz / 169 fps
922 fps
60dB
Mono CCD: 8, 10, 12
Color CCD: 8, 10, 12
TRUESENSE Sparse CFA
Manual, Auto: 0 - 36dB 1024 steps
Manual, 1024 steps
Manual
Manual
Manual, auto, off
1us/step, 1/500,000 to 1/64 sec (nom)
Manual, auto, external
Up to 16 seconds
7 ROIs, any line to any line, any pixel to any pixel
1x, 2x, 3x, 4x, 8x (Independent for H & V)
External (TTL via IN1/IN2), pulse generator, software, computer
Level, edge, pulse width, internal exposure, up to 16 seconds trigger delay, debounce
Free-run, standard, double, fast, asynchronous, frame accumulation
Time: 200 nanoseconds
2 IN, 2 OUT, user programmable
2 strobes, programmable position and duration
Yes, programmable
Yes, programmable
Optical center, programmable H & V lines
Threshold, contrast enhancement, knee correction, horizontal flip, negative image, bit shift (+/- 7 places)
2Gb (256 MB)
G=1.0, G=0.45, user upgradeable LUT
Defective/hot pixel correction (static, dynamic), black level, vertical smear
1 Lux, F/ 1.4
C-Mount (Default), CS
Auto, programmable
Manual, user programmable (motorized lens, custom)
12VDC (10V - 15V), 1.5 A inrush
CLM 6.7 W, CXP-TBD
60mm (W) x 60mm (H) – Applies to all interfaces
CLM 53.1mm (L), CXP -TBD
CLM 337g, CXP -TBD
100g (20-200) HZ XYZ, 1000g
-40°C to +85°C Operating, -50°C to +90°C Storage
10% to 90% non-condensing
>660,000 hours @ 40°C
FCC 15 part A, CE, RoHS

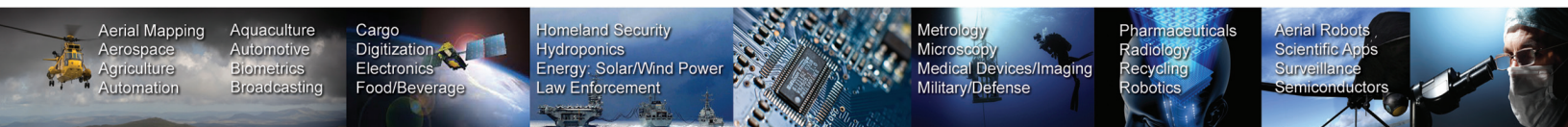
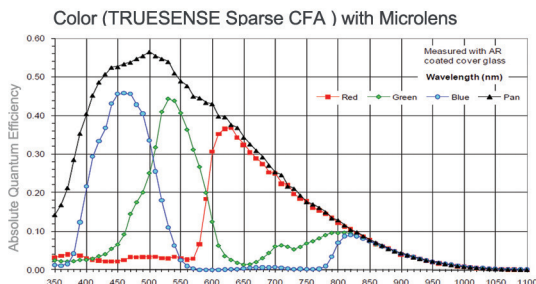
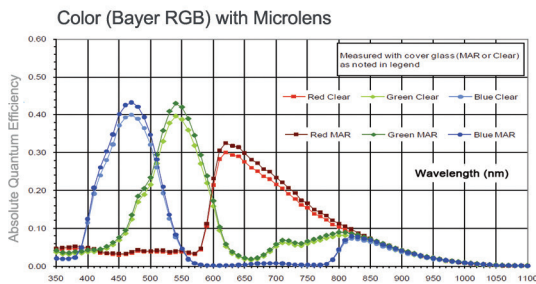
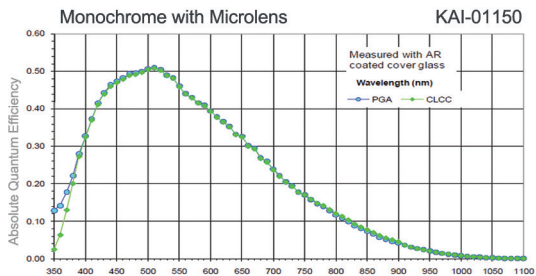

Aerial Mapping
Aerospace
Agriculture
Automation

Aquaculture
Automotive
Biometrics
Broadcasting

Cargo Digitization
Electronics
Food/Beverage

Homeland Security
Hydroponics
Energy, Solar/Wind Power
Law Enforcement

Metrology
Microscopy
Medical Devices/Imaging
Military/Defense

Pharmaceuticals
Radiology
Recycling
Robotics

Aerial Robots
Scientific Apps
Surveillance
Semiconductors

BOBCAT 2.0 B1340 Specifications

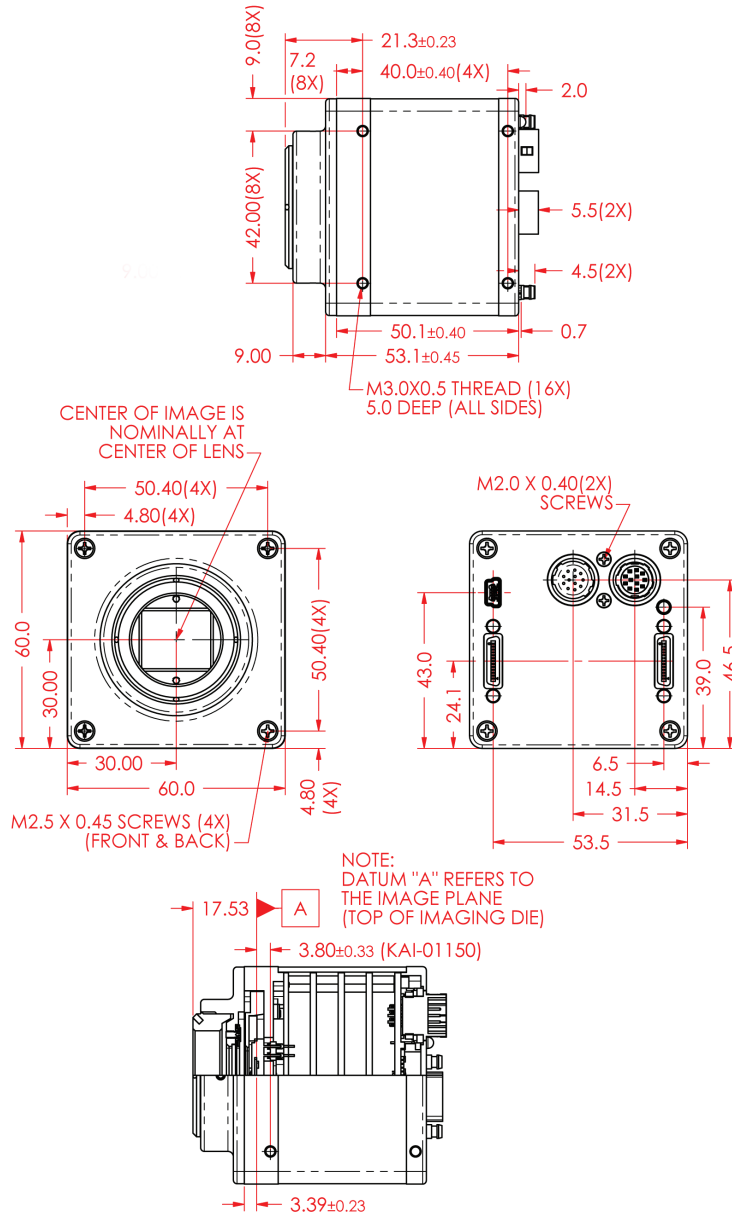

Hirose Connectors

Power and I/O Interface

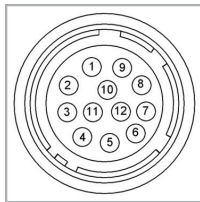

- | | |
|-------------------|-----------------|
| 1 12V DC Return * | 7 OUT1 Signal |
| 2 +12V DC* | 8 IN1 Signal |
| 3 IRIS VCC | 9 IN2 Signal |
| 4 IRIS Video | 10 IN1/2 Return |
| 5 IRIS Return | 11 Reserved |
| 6 OUT1/2 Return | 12 OUT2 Signal |

Connector: Hirose HR 10A- 10R- 12PB(71)
 *Not connected for CXP

Lens Control/RS232

See manual for PIN information

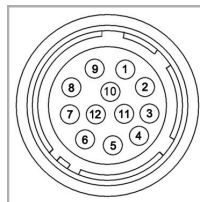

- | | |
|---------------|-------------|
| 1 IRIS Return | 7 FOCUS + |
| 2 IRIS VCC | 8 ZOOM - |
| 3 IRIS Video | 9 ZOOM + |
| 4 IRIS - | 10 UART_COM |
| 5 IRIS + | 11 UART_RX |
| 6 FOCUS - | 12 UART_TX |

Connector: Hirose HR 10A- 10R- 12SB(71)

B1340 Ordering Information

Interfaces available

- Camera Link® Medium (CLM)
- CoaXPress (CXP)

Sensor types available

- Monochrome
- Bayer Color
- TRUESENSE Sparse CFA

Accessories (Sold separately)

- PS12v04-Power Supply w/ 1 input and 1 output
- PS12v05-Power Supply (as above) and Video Iris



WWW.IMPERX.COM



bobcat-B1340-v2,Rev1